

# **TIERS LIEU I'EPLEFPA**

**« PENSER ENSEMBLE VERS UNE  
ALIMENTATION DURABLE »**

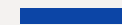

Maria Pedrosa

**VALORISER LA DIVERSITÉ  
DES CONNAISSANCES**

**AVOIR UNE VISION  
D'ENSEMBLE**

**METTRE LES PARTIES  
PRENANTES ENSEMBLE**

**DISTRIBUER DES RÔLES  
POUR ENGAGER**

**FAVORISER L'INNOVATION  
ET LA CRÉATIVITÉ**

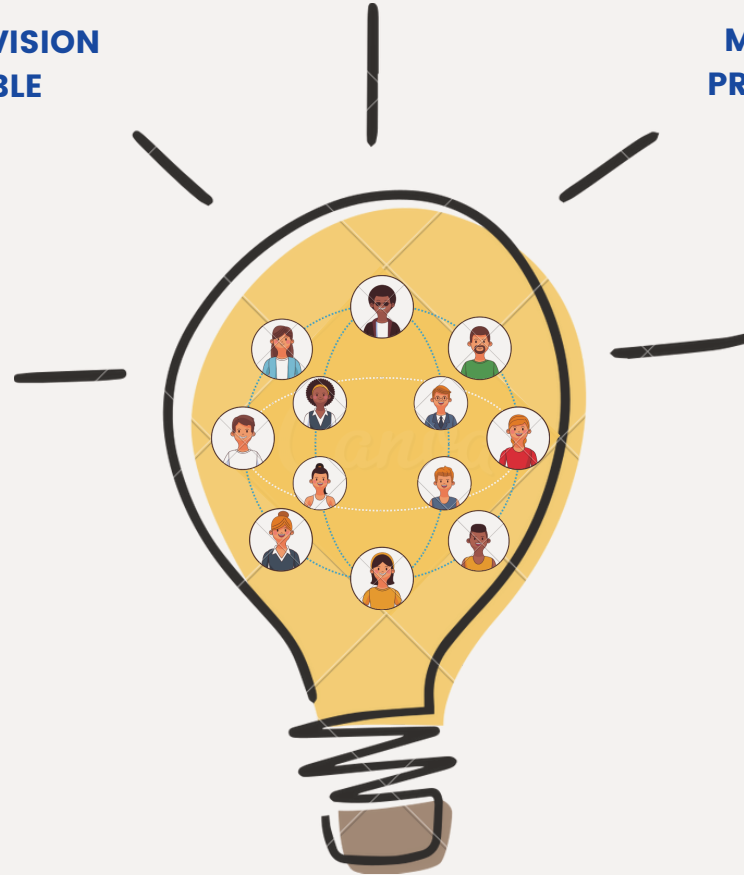

**L'INTELLIGENCE COLLECTIVE**

# LES ACTIVITÉS

**Exposés  
"Pecha  
Kucha"**

**Accueil des  
écoles  
de Lomme**

**Café time  
+  
Rencontres**

**Marché  
Drive fermier**

**Atelier  
experiment.**

**Atelier  
intergén.**

**Ateliers  
mutualisés**

**Atelier  
Dégustation**

# LES PRINCIPES SPATIAUX

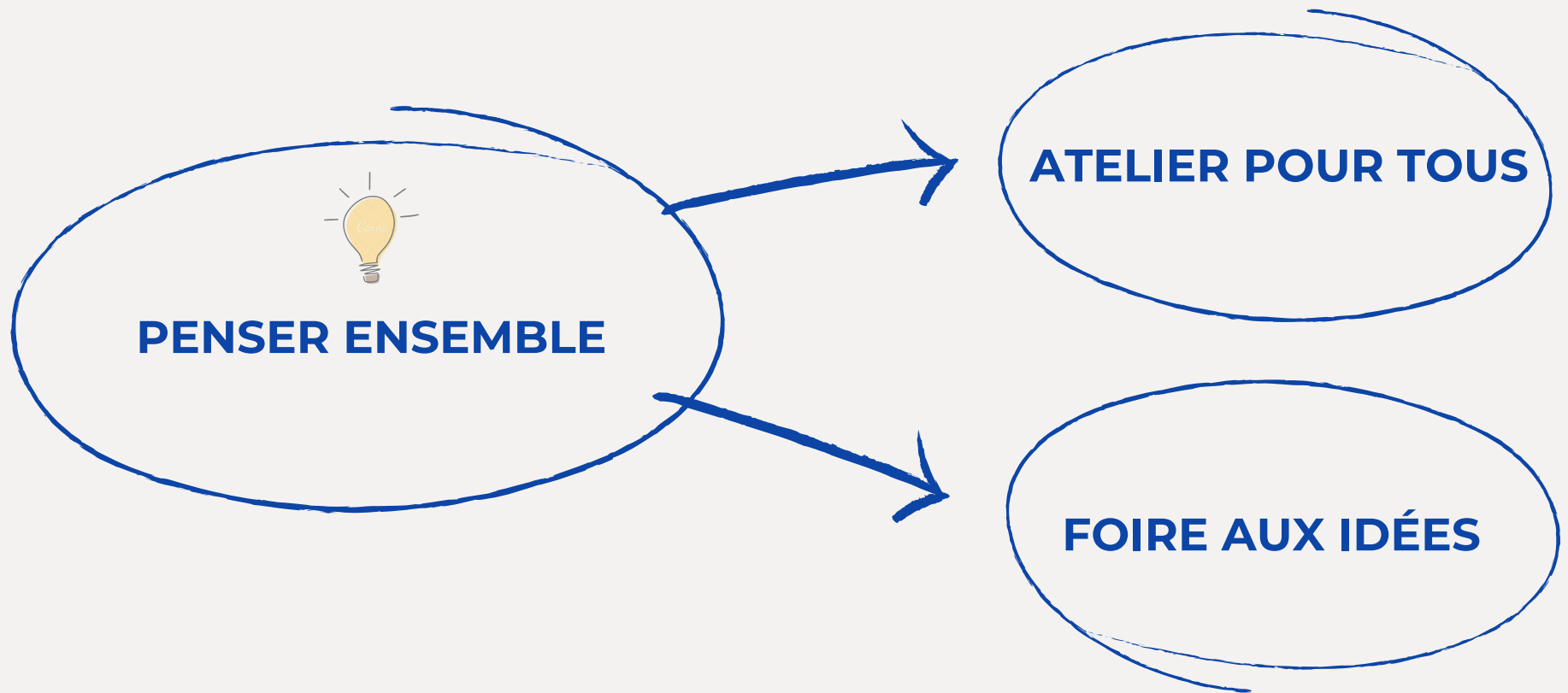



**ATELIER  
POUR TOUS**



**MOB. RANGEMENT**

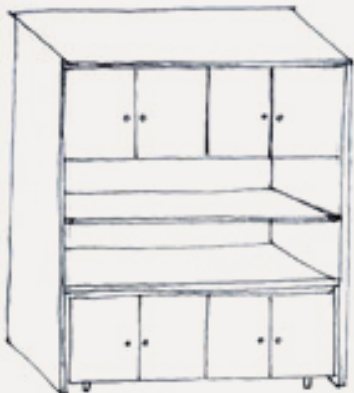

**MOB. CAFE TIME**

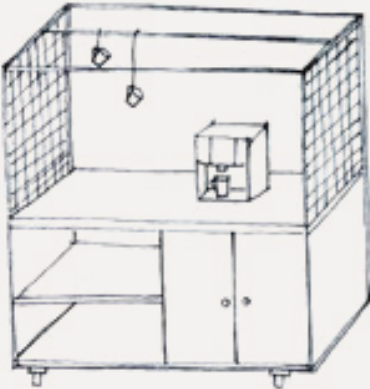



**MOB. RANGEMENT**

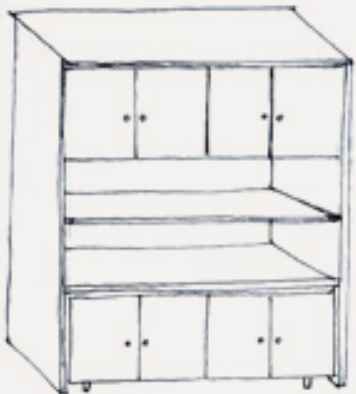

**MOB. CAFE TIME**

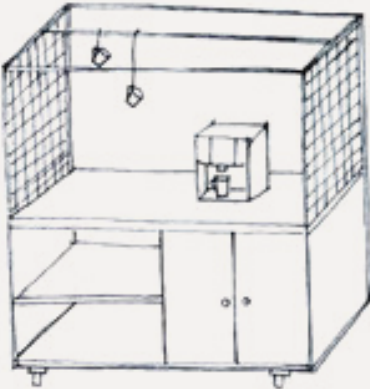

# MOB. RANGEMENT



# MOB. CAFE TIME

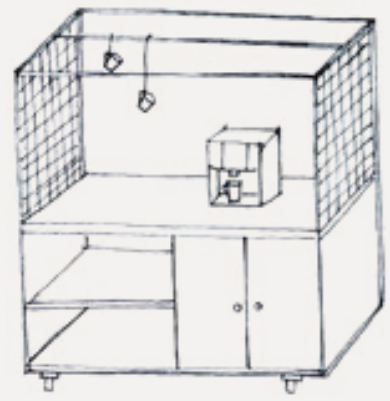



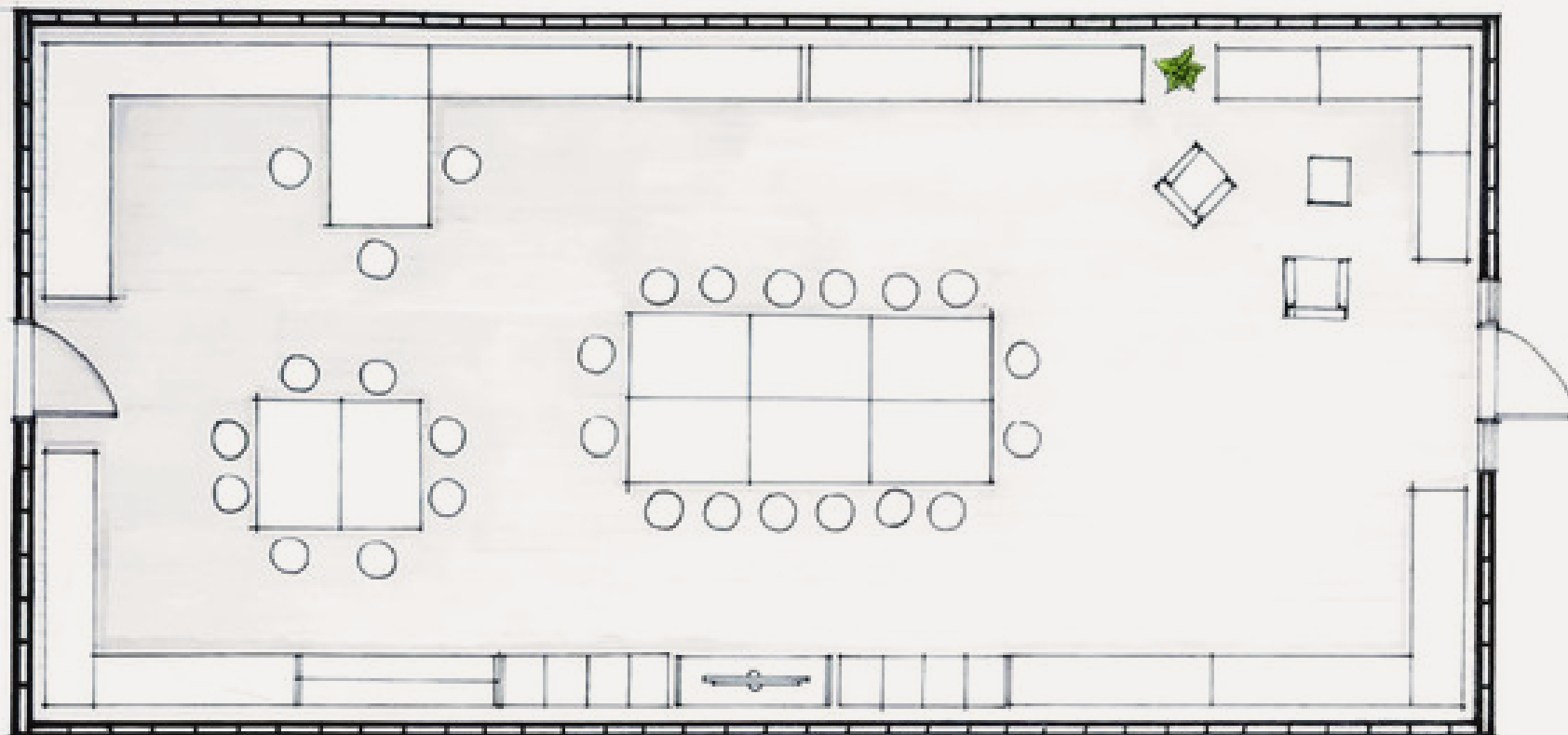

**PLAN TIERS LIEU - ATELIER POUR TOUS**

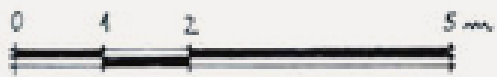

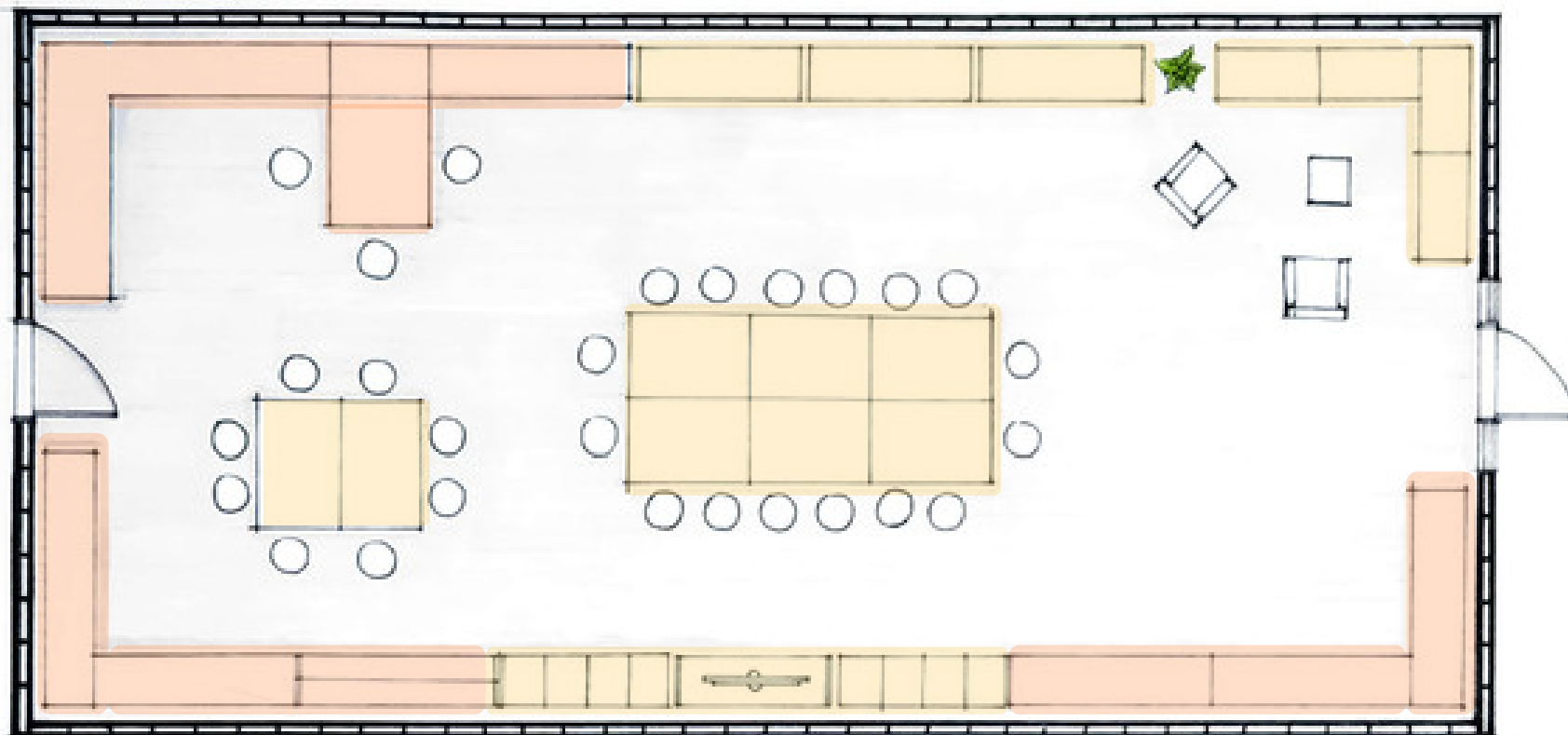

## PLAN TIERS LIEU - ATELIER POUR TOUS



- MEUBLES FIXES
- MEUBLES MOBILES



**COUPE - ATELIER POUR TOUS**





**COUPE - ATELIER POUR TOUS**

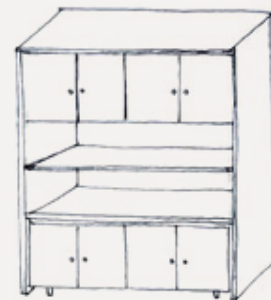
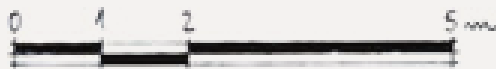



**COUPE - ATELIER POUR TOUS**

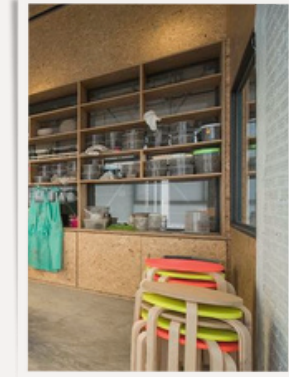
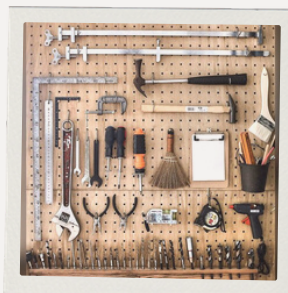

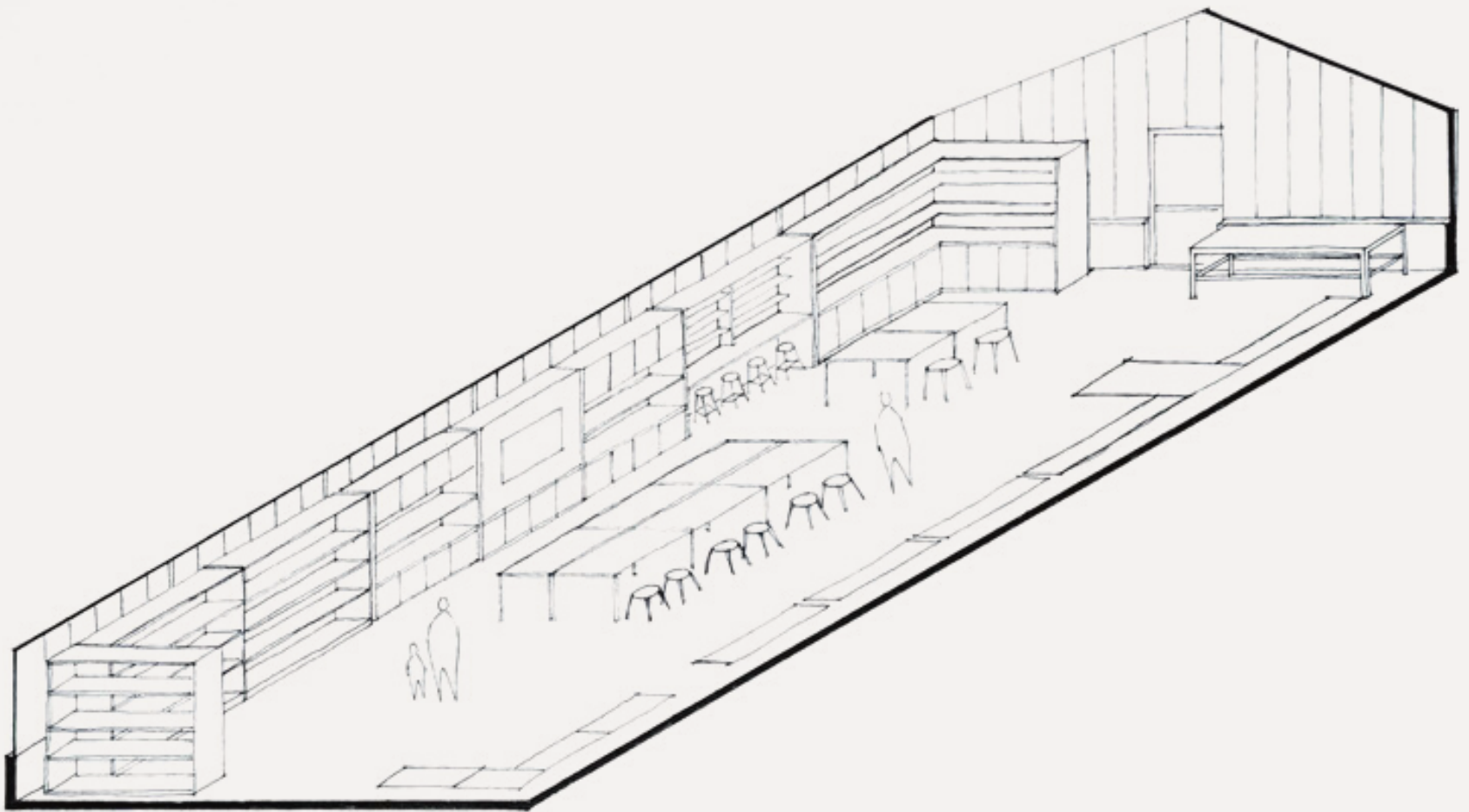





**FOIRE AUX  
IDÉES**







FOIRE AUX  
IDÉES

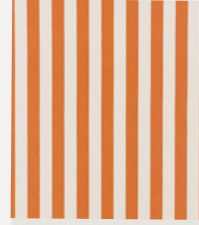



## STAND 01

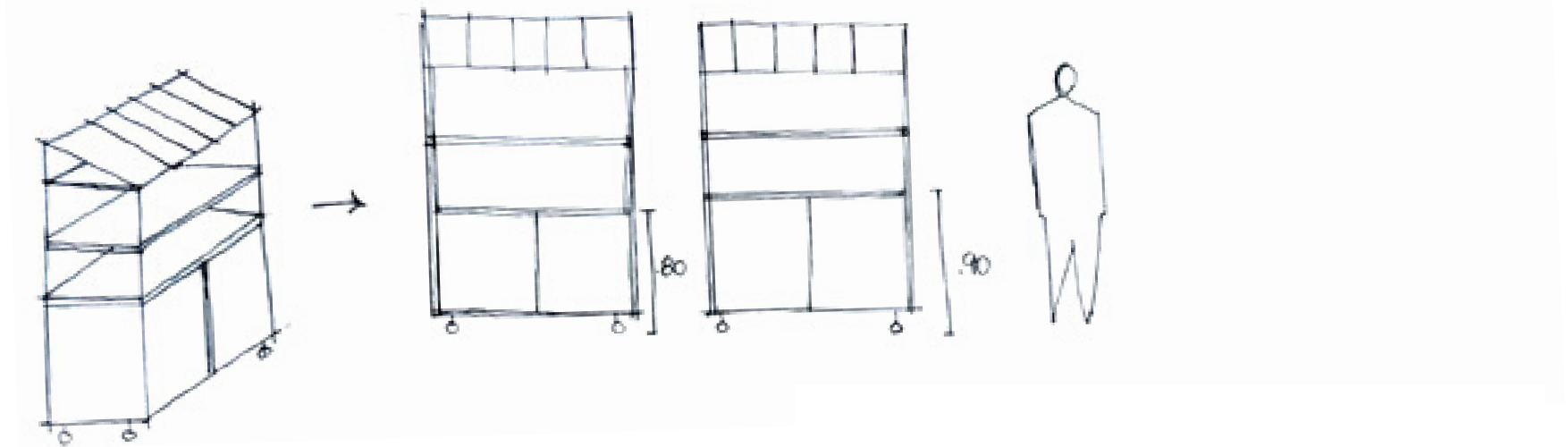

## STAND 02

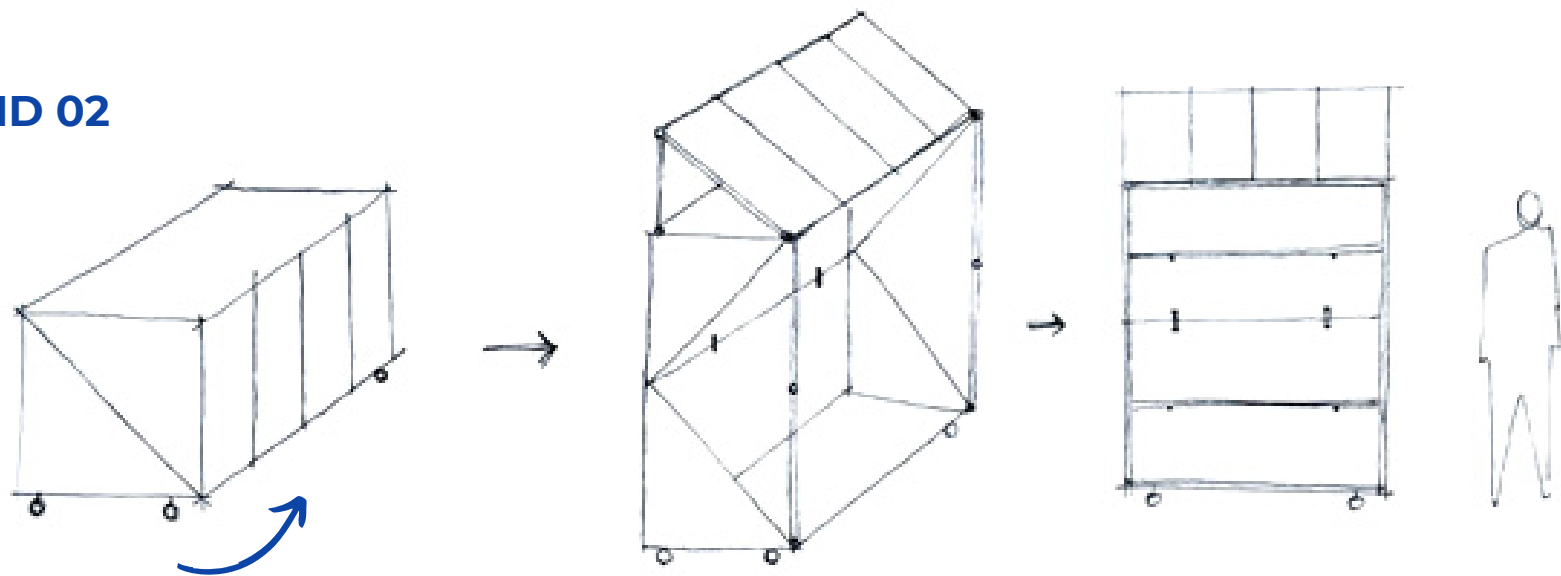

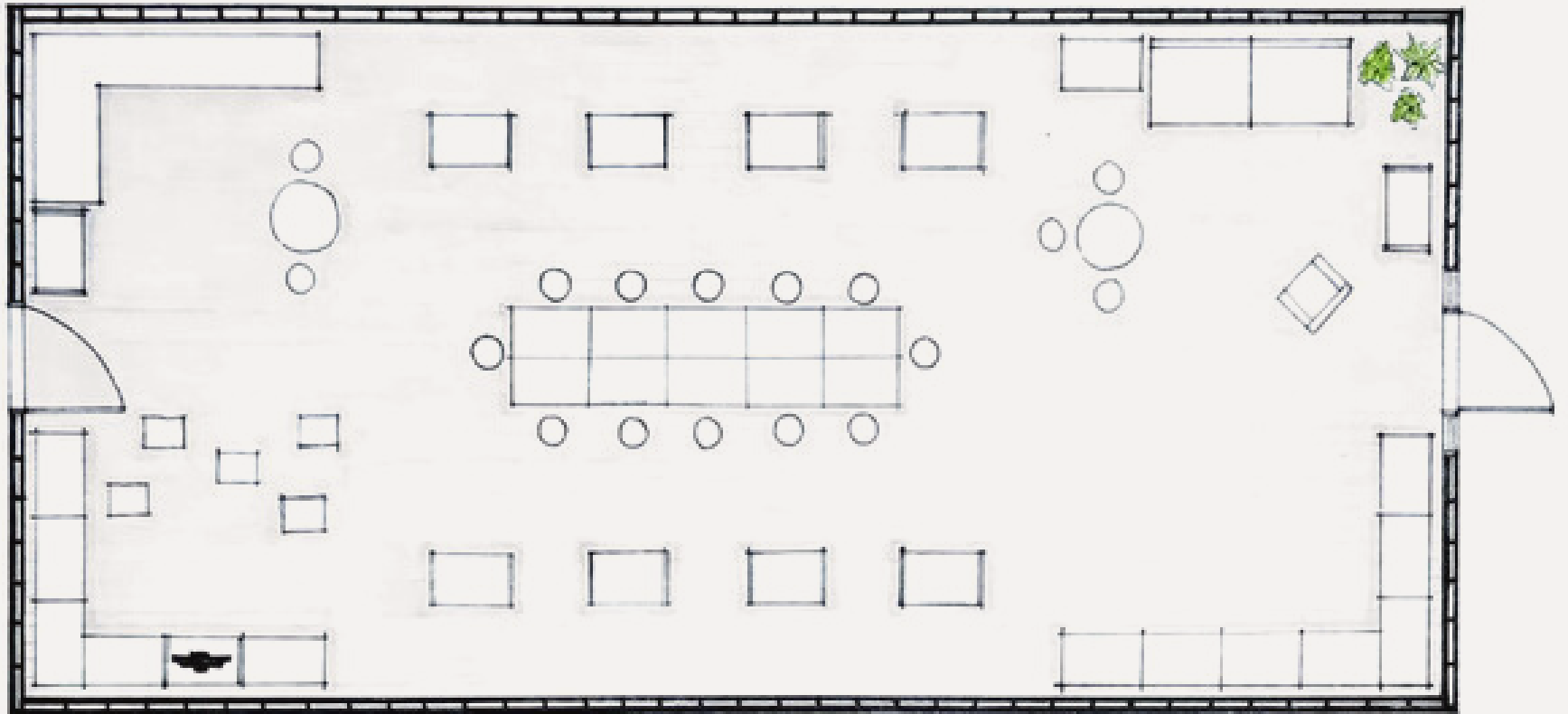

## PLAN TIERS LIEU - FOIRE AUX IDÉES



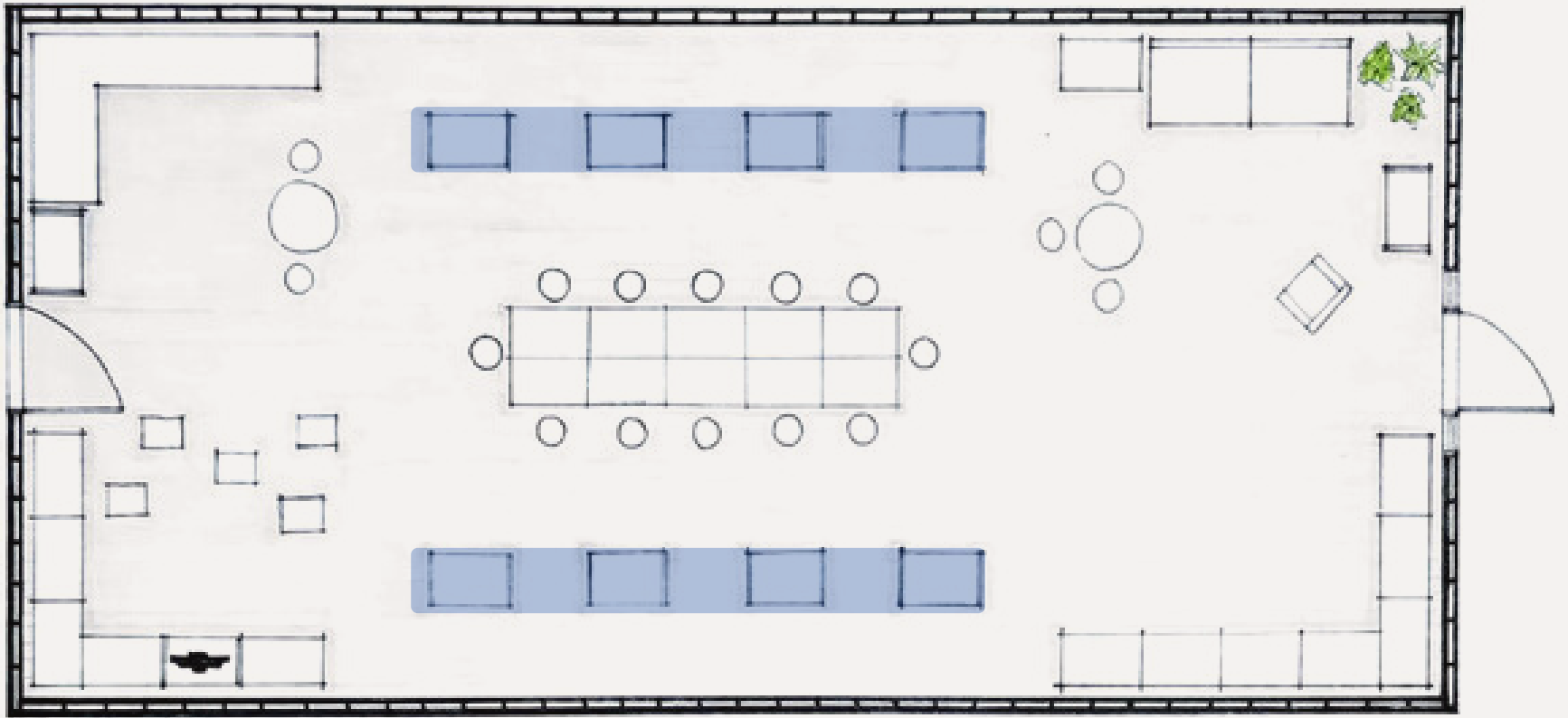

## PLAN TIERS LIEU - FOIRE AUX IDÉES





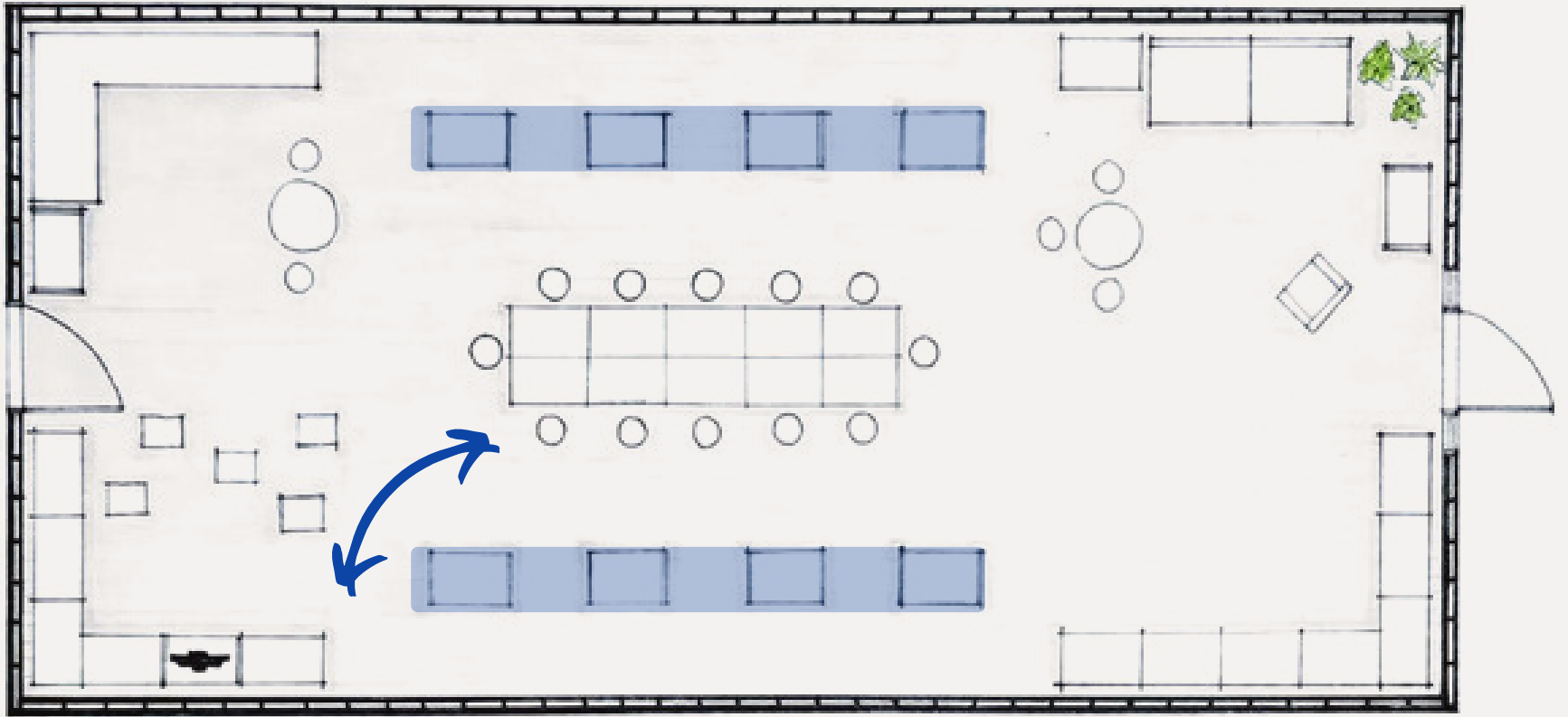

## PLAN TIERS LIEU - FOIRE AUX IDÉES



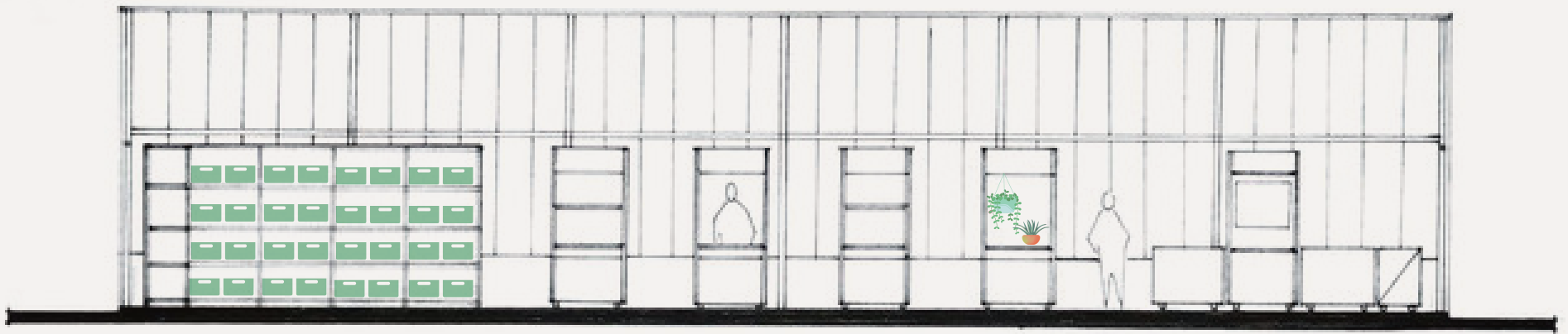

## COUPE - FOIRE AUX IDÉES



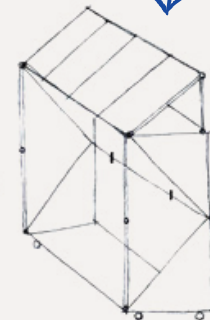
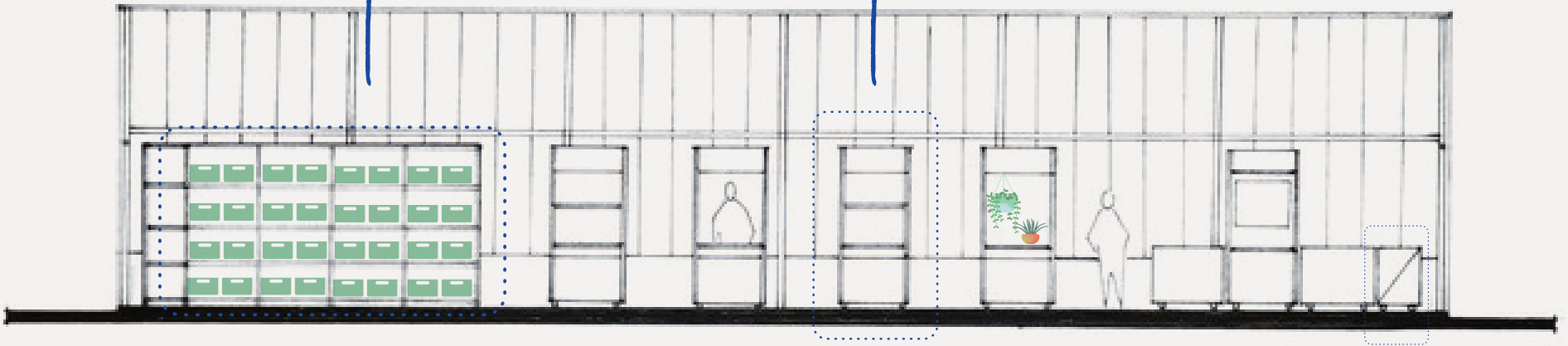

# COUPE - FOIRE AUX IDÉES



